



Cambridge International Examinations
Cambridge International General Certificate of Secondary Education

CANDIDATE
NAME

CENTRE
NUMBER

--	--	--	--	--

CANDIDATE
NUMBER

--	--	--	--

* 7 2 2 5 0 2 4 0 0 4 *

CHEMISTRY

0620/23

Paper 2

October/November 2015

1 hour 15 minutes

Candidates answer on the Question Paper.

No Additional Materials are required.

READ THESE INSTRUCTIONS FIRST

Write your Centre number, candidate number and name in the spaces at the top of this page.

Write in dark blue or black pen.

You may use an HB pencil for any diagrams or graphs.

Do not use staples, paper clips, glue or correction fluid.

DO **NOT** WRITE IN ANY BARCODES.

Answer **all** questions.

Electronic calculators may be used.

A copy of the Periodic Table is printed on page 16.

You may lose marks if you do not show your working or if you do not use appropriate units.

At the end of the examination, fasten all your work securely together.

The number of marks is given in brackets [] at the end of each question or part question.

The syllabus is approved for use in England, Wales and Northern Ireland as a Cambridge International Level 1/Level 2 Certificate.

This document consists of **16** printed pages.

1 The structures of six gases are shown below.

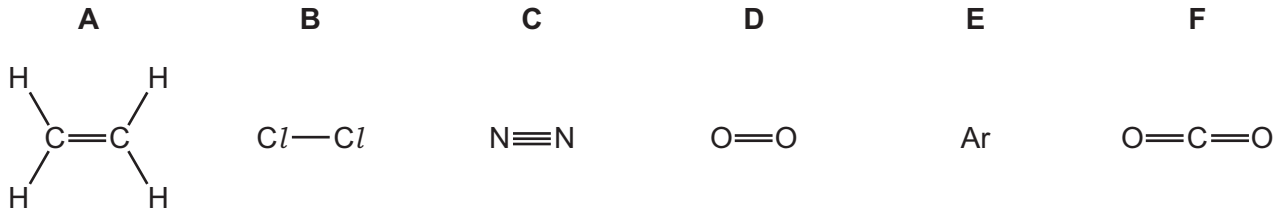

Answer the following questions about these gases.
Each gas may be used once, more than once or not at all.

(a) Which gas, **A**, **B**, **C**, **D**, **E** or **F**

- | | |
|-----------------------------------|-----------|
| (i) bleaches damp litmus paper, | [1] |
| (ii) forms 79% of the air, | [1] |
| (iii) is a noble gas, | [1] |
| (iv) can undergo polymerisation, | [1] |
| (v) decolourises aqueous bromine, | [1] |
| (vi) is a product of respiration? | [1] |

(b) Gas **F** is a compound.

Define the term *compound*.

.....
 [1]

(c) Give a use for gas **E**.

..... [1]

(d) When magnesium is heated in gas **C** magnesium nitride, Mg_3N_2 , is formed.

Complete the symbol equation for this reaction.



[Total: 9]

- 2 Household waste can be burned to produce energy.
The table shows the energy released by different materials when the waste is burned.

material burned	mass burned / kg	energy released / kJ
metals	1.0	1 000
organic matter	0.5	8 000
paper	2.0	40 000
plastics	1.0	30 000
cloth	1.0	15 000

- (a) Which material releases the most energy per kilogram when burned?

..... [1]

- (b) Which **one** of the following words best describes the energy change when a substance is burned?

Tick **one** box.

endothermic

neutralisation

exothermic

reduction

[1]

- (c) The structure of part of a plastic is shown below.

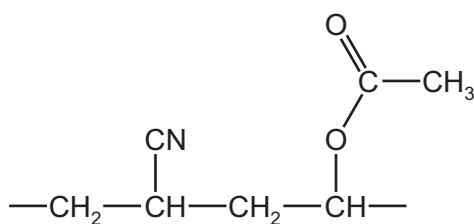

How many different types of atom are present in this plastic?

..... [1]

(d) Waste paper can be converted into an 'oil' by heating it at 350 °C under pressure in the presence of a catalyst.

(i) What is the purpose of the catalyst?

..... [1]

(ii) The 'oil' has the formula, $C_{22}H_{22}O_2$.

Complete the word equation for the complete combustion of this oil.

'oil' + oxygen → + [2]

(e) Some plastics contain sulfur.

Explain why plastics containing sulfur are harmful to the environment when burned.

.....
 [2]

(f) When organic matter decomposes, methane and carboxylic acids are formed.

(i) To which homologous series does methane belong?

..... [1]

(ii) Ethanoic acid is a carboxylic acid.

State **one** physical property of ethanoic acid.

..... [1]

(iii) Complete the formula for ethanoic acid showing all atoms and all bonds.

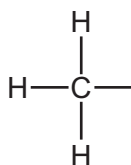

[1]

[Total: 11]

- 3 Hydrogen chloride can be prepared in the laboratory by heating sodium chloride with concentrated sulfuric acid using the apparatus shown below.

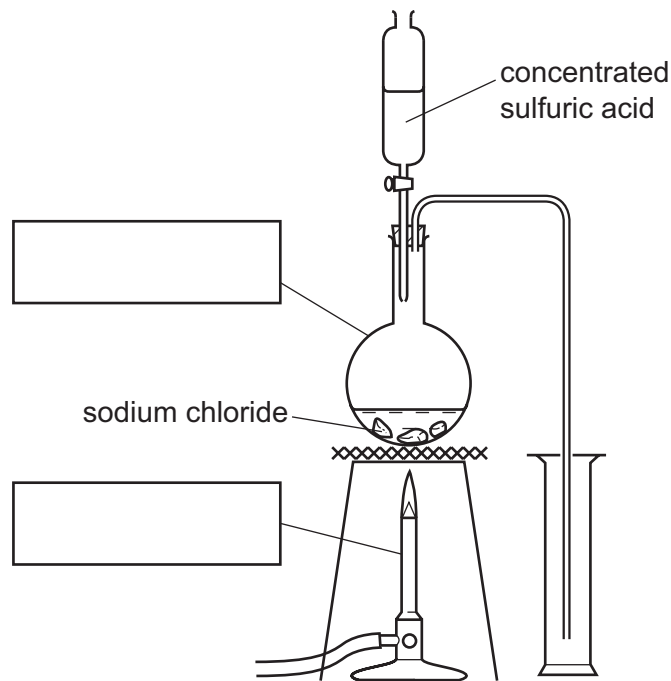

- (a) Complete the diagram by adding the labels in the boxes. [2]

- (b) The equation for the reaction is shown below.



State the name of the salt formed as a product in this reaction.

..... [1]

(c) Hydrogen chloride gas dissolves in water to form hydrochloric acid.

(i) The diagram below shows the apparatus used to electrolyse concentrated hydrochloric acid.

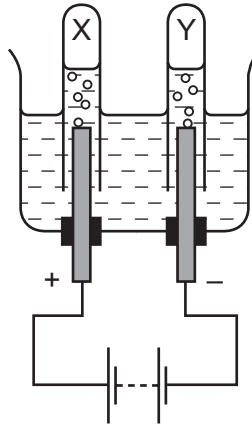

Label the diagram to show

- the anode,
- the cathode,
- the electrolyte.

[2]

(ii) Give the names of the gases collected at

X,

Y,

[2]

(iii) Complete the word equation for the reaction of hydrochloric acid with calcium carbonate.



[3]

- (d) Aqueous ammonia is added slowly to a beaker containing hydrochloric acid. The graph below shows how the pH of the solution in the flask changes as the aqueous ammonia is added.

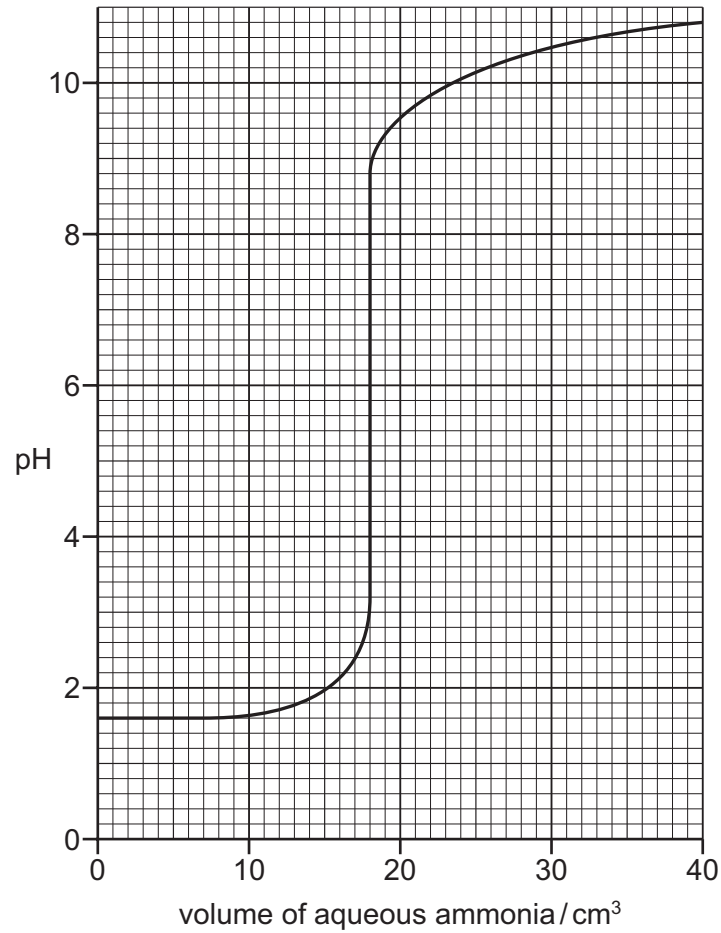

- (i) What was the pH of the hydrochloric acid at the start of the experiment?

..... [1]

- (ii) Describe how the pH of the solution changes as the titration proceeds.

.....

 [3]

[Total: 14]

- 4 Ethanol can be made by fermenting glucose.

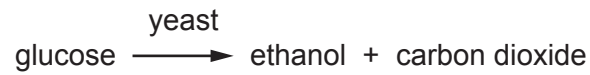

A student investigated the fermentation of glucose at 30 °C. She used the apparatus shown below.

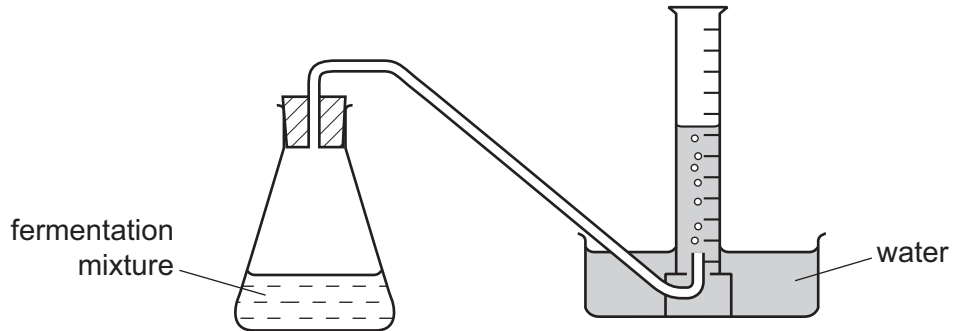

- (a) Describe how this apparatus can be used to investigate the rate of this reaction.

.....

.....

..... [3]

(b) The graph below shows how the rate of fermentation changes with time.

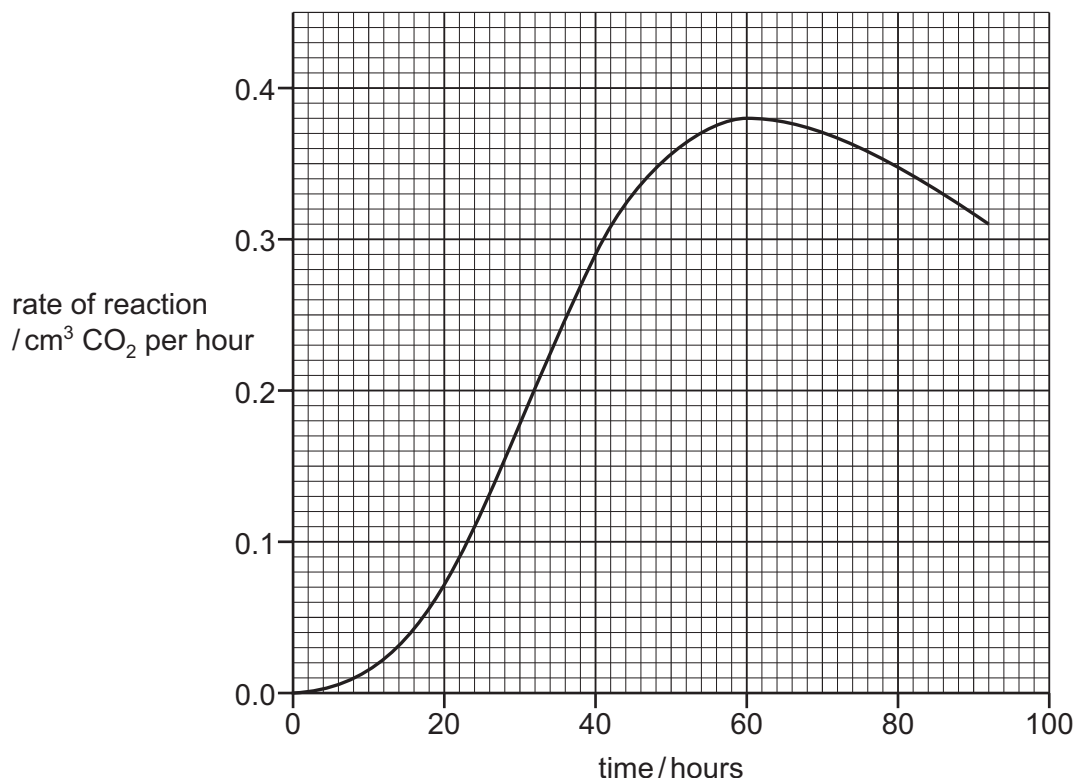

(i) Describe how the rate of fermentation changes with time.

.....
 [2]

(ii) What is the rate of reaction 40 hrs after the start of the experiment?

..... cm³ CO₂ per hour [1]

(iii) Suggest **two** ways to increase the rate of this reaction.

1
 2 [2]

(c) If air is introduced into the fermentation mixture, some of the ethanol is converted to ethanoic acid.

Ethanoic acid has properties which are typical of most acids.

Suggest how you could distinguish between ethanoic acid and ethanol.

.....
 [2]

[Total: 10]

- 5 (a) Mercury is a liquid at room temperature. When heated, it changes to mercury vapour.

Explain, using the kinetic particle theory, the differences in the arrangement and motion of the particles in liquid mercury and mercury vapour.

.....

.....

.....

.....

..... [4]

- (b) The table below compares the properties of some metals.

metal	melting point /°C	boiling point /°C	corrosion resistance
aluminium	660	2467	resistant to corrosion because of oxide layer
copper	1083	2567	fairly resistant to corrosion
iron	1535	2750	corrodes easily
potassium	63	760	corrodes very easily

Use the information in the table to answer the following questions.

- (i) What is the state of potassium at 100 °C?
Explain your answer.

.....

..... [2]

- (ii) Which **two** metals in the table are transition elements?
Explain your answer.

.....

..... [2]

- (iii) Why is aluminium used for food containers?

..... [1]

(c) Iron undergoes a form of corrosion called rusting.

(i) State the conditions needed for rusting?

..... and [2]

(ii) Explain why painting a clean iron object prevents it from rusting.

..... [1]

(d) Iron reacts with hydrochloric acid. A salt with the formula FeCl_2 is formed as well as a gas which pops with a lighted splint.

(i) Complete the word equation for this reaction.

iron + hydrochloric acid \rightarrow + [2]

(ii) Describe a test for iron(II) ions.

test

result [2]

(e) Stainless steel is an alloy of iron.

Give **one** use of stainless steel.

..... [1]

[Total: 17]

- 6 Petroleum is a mixture of hydrocarbons. Hydrocarbon fractions are separated in an oil refinery. The diagram shows the chemical plant used.

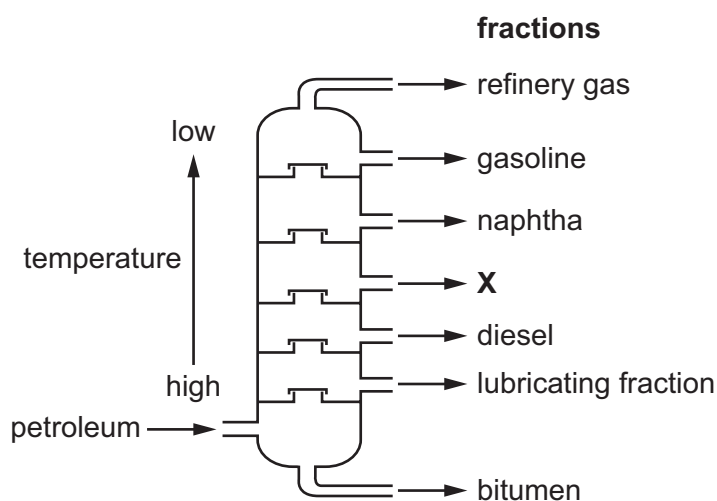

- (a) Name the process by which hydrocarbon fractions are separated and state the physical property which allows this process to be carried out.

.....
 [2]

- (b) Use the information in the diagram above to answer these questions.

- (i) Which fraction contains hydrocarbons with the lowest relative molecular masses?

..... [1]

- (ii) State the name of the fraction labelled X.

..... [1]

- (c) In some oil refineries, naphtha is heated with steam at 800 °C.
A mixture of hydrocarbons is formed.
Some of these hydrocarbons are shown below.

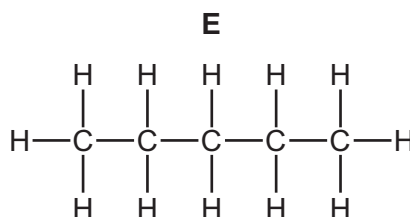
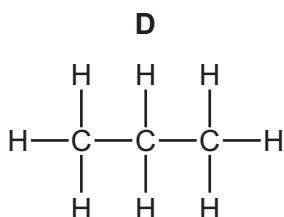
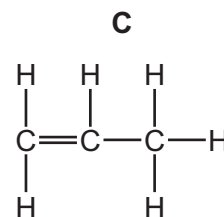
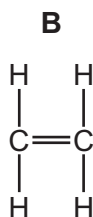
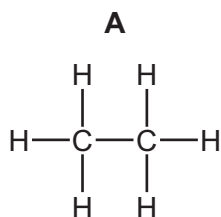

- (i) Which **two** of these hydrocarbons are unsaturated?

..... and [1]

- (ii) Compound **D** can be cracked to make hydrogen.

Complete the symbol equation for this reaction.



[2]

- (d) Bitumen is a mixture of hydrocarbons.
Bitumen is heated with copper(II) oxide.

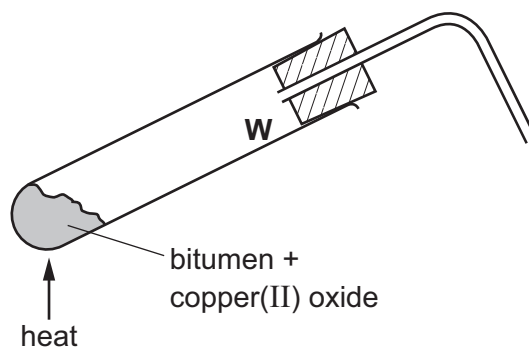

- (i) A pinkish-brown solid appears at the bottom of the test-tube. This solid conducts electricity.
Suggest the name of this pinkish-brown solid.

..... [1]

- (ii) Water collects on the walls of the test-tube at **W**.

Suggest why water collects at this point?

..... [1]

[Total: 9]

- 7 (a) Chlorine is in Group VII of the Periodic Table.
One isotope of a chlorine atom has a nucleon number of 35.

Describe the structure of an atom of this isotope of chlorine.
In your answer refer to

- the type and number of each subatomic particle present,
- the charges on each type of subatomic particle,
- the position of each type of subatomic particle in the atom.

.....

.....

.....

.....

.....

.....

.....

.....

.....

..... [5]

- (b) Chlorine reacts with sodium to form sodium chloride.
Sodium chloride contains Na^+ ions and Cl^- ions.

Explain why sodium ions are positively charged and chloride ions are negatively charged.

.....

.....

..... [2]

- (c) When chlorine reacts with aqueous potassium iodide, the solution turns brown.

- (i) Suggest why the solution turns brown.

..... [1]

- (ii) Explain why aqueous potassium chloride does **not** react with iodine.

..... [1]

(d) The structure of a chlorofluorocarbon is shown below.

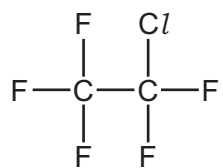

Deduce the molecular formula of this compound.

..... [1]

[Total: 10]

DATA SHEET
The Periodic Table of the Elements

Group		I	II	III	IV	V	VI	VII	0									
		1 H Hydrogen 1							4 He Helium 2									
7 Li Lithium 3	9 Be Beryllium 4				11 B Boron 5	12 C Carbon 6	13 Al Aluminium 13	14 N Nitrogen 7	15 O Oxygen 8	16 F Fluorine 9	17 Ne Neon 10							
23 Na Sodium 11	24 Mg Magnesium 12			27 Al Aluminium 13	28 Si Silicon 14	29 P Phosphorus 15	30 S Sulfur 16	31 Cl Chlorine 17	32 Ar Argon 18									
39 K Potassium 19	40 Ca Calcium 20	45 Sc Scandium 21	48 Ti Titanium 22	51 V Vanadium 23	52 Cr Chromium 24	55 Mn Manganese 25	56 Fe Iron 26	59 Co Cobalt 27	59 Ni Nickel 28	64 Cu Copper 29	65 Zn Zinc 30	70 Ga Gallium 31	73 Ge Germanium 32	75 As Arsenic 33	76 Se Selenium 34	79 Br Bromine 35	80 Kr Krypton 36	
85 Rb Rubidium 37	88 Sr Strontium 38	89 Y Yttrium 39	91 Zr Zirconium 40	93 Nb Niobium 41	96 Mo Molybdenum 42	101 Tc Technetium 43	101 Ru Ruthenium 44	103 Rh Rhodium 45	106 Pd Palladium 46	108 Ag Silver 47	112 Cd Cadmium 48	115 In Indium 49	119 Sn Tin 50	122 Sb Antimony 51	128 Te Tellurium 52	127 I Iodine 53	131 Xe Xenon 54	
133 Cs Caesium 55	137 Ba Barium 56	139 La Lanthanum 57	178 Hf Hafnium * 72	181 Ta Tantalum 73	184 W Tungsten 74	186 Re Rhenium 75	190 Os Osmium 76	192 Ir Iridium 77	195 Pt Platinum 78	197 Au Gold 79	201 Hg Mercury 80	204 Tl Thallium 81	207 Pb Lead 82	209 Bi Bismuth 83	210 Po Polonium 84	210 At Astatine 85	210 Rn Radon 86	
87 Fr Francium	88 Ra Radium	89 Ac Actinium †																

140 Ce Cerium 58	141 Pr Praseodymium 59	144 Nd Neodymium 60	150 Sm Samarium 62	152 Eu Europium 63	157 Gd Gadolinium 64	162 Dy Dysprosium 66	165 Ho Holmium 67	167 Er Erbium 68	169 Tm Thulium 69	173 Yb Ytterbium 70	175 Lu Lutetium 71	
232 Th Thorium 90	238 U Uranium 92	238 Pa Protactinium 91	94 Pu Plutonium 94	95 Am Americium 95	96 Cm Curium 96	97 Bk Berkelium 97	98 Cf Californium 98	99 Es Einsteinium 99	100 Fm Fermium 100	101 Md Mendelevium 101	102 No Nobelium 102	103 Lr Lawrencium 103

*58-71 Lanthanoid series
†90-103 Actinoid series

a = relative atomic mass
X = atomic symbol
b = proton (atomic) number

Key

a	X
b	

The volume of one mole of any gas is 24 dm³ at room temperature and pressure (r.t.p.).