



UNIVERSITY OF CAMBRIDGE INTERNATIONAL EXAMINATIONS  
International General Certificate of Secondary Education

CANDIDATE  
NAME

CENTRE  
NUMBER

--	--	--	--	--

CANDIDATE  
NUMBER

--	--	--	--



**PHYSICS**

**0625/52**

Paper 5 Practical Test

**May/June 2013**

**1 hour 15 minutes**

Candidates answer on the Question Paper.

Additional Materials: As listed in the Confidential Instructions.

**READ THESE INSTRUCTIONS FIRST**

Write your Centre number, candidate number and name in the spaces at the top of the page.

Write in dark blue or black pen.

You may use a pencil for any diagrams, graphs or rough working.

Do not use staples, paper clips, highlighters, glue or correction fluid.

**DO NOT WRITE IN ANY BARCODES.**

Answer **all** questions.

Electronic calculators may be used.

You may lose marks if you do not show your working or if you do not use appropriate units.

At the end of the examination, fasten all your work securely together.

The number of marks is given in brackets [ ] at the end of each question or part question.

For Examiner's Use	
1	
2	
3	
4	
<b>Total</b>	

This document consists of **11** printed pages and **1** blank page.



1 In this experiment, you will determine the mass of a metre rule using two methods.

**Method 1.**

Carry out the following instructions, referring to Fig. 1.1.

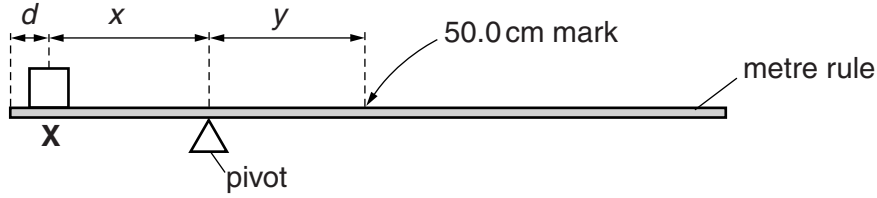

**Fig. 1.1**

You are provided with a 100 g mass, labelled **X**.

- (a) (i) Place the mass **X** on the rule so that its centre is at a distance  $d = 5.0$  cm from the zero end of the rule, as shown in Fig. 1.1. Record the value of  $d$  in Table 1.1.
- (ii) Adjust the position of the rule so that it is as near as possible to being balanced, with the 50.0 cm mark to the right of the pivot.
- (iii) Measure, and record in the table, the distance  $x$  from the centre of the mass **X** to the pivot.
- (iv) Measure, and record in the table, the distance  $y$  from the pivot to the 50.0 cm mark on the rule.
- (v) Repeat the steps (i) – (iv) using  $d = 10.0$  cm.

**Table 1.1**

$d/\text{cm}$	$x/\text{cm}$	$y/\text{cm}$

[3]

- (b) (i) Using the values of  $x$  and  $y$  in the first row of the table, calculate the mass  $M$  of the rule using the equation

$$M = \frac{100x}{y}.$$

$M = \dots\dots\dots$ [1]

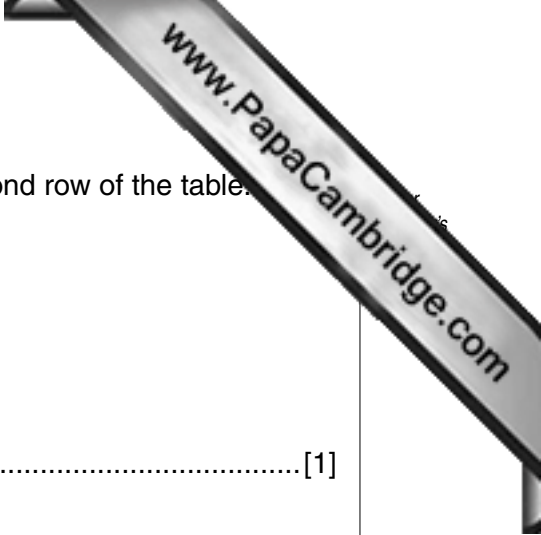

(ii) Repeat step (b)(i) using the values of  $x$  and  $y$  in the second row of the table.

$M = \dots\dots\dots$  [1]

(iii) Calculate the average value of  $M$ .

average value of  $M = \dots\dots\dots$  [1]

**Method 2.**

(c) Measure the mass  $M$  of the rule using the balance provided.

$M = \dots\dots\dots$  [1]

(d) A student carrying out this experiment expects that the values of the mass  $M$  obtained by the two methods will be exactly the same.

Suggest two practical reasons why, in spite of following the instructions with care, the values may differ. Assume that the balance used in Method 2 is accurate.

- 1. ....  
.....
- 2. ....  
.....

[2]

**Question 1 continues on the next page.**

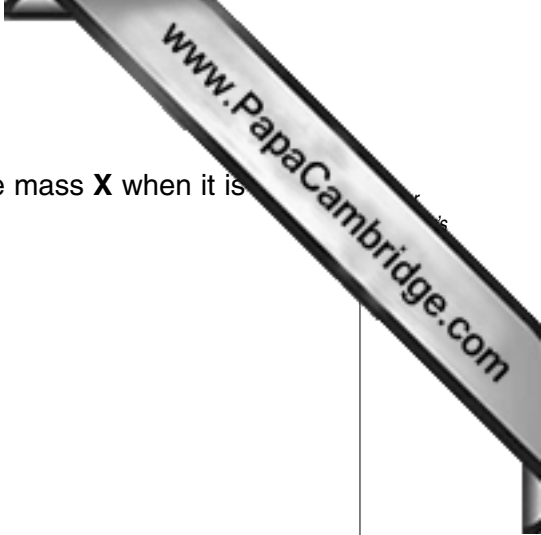

(e) Explain briefly how you judge the position of the centre of the mass **X** when it is in equilibrium. You may draw a diagram.

.....

.....

..... [1]

[Total: 10]



- 2 In this experiment, you will investigate the cooling of water.

You are provided with a supply of hot water and a supply of cold water. Carry out the following instructions, referring to Fig. 2.1.

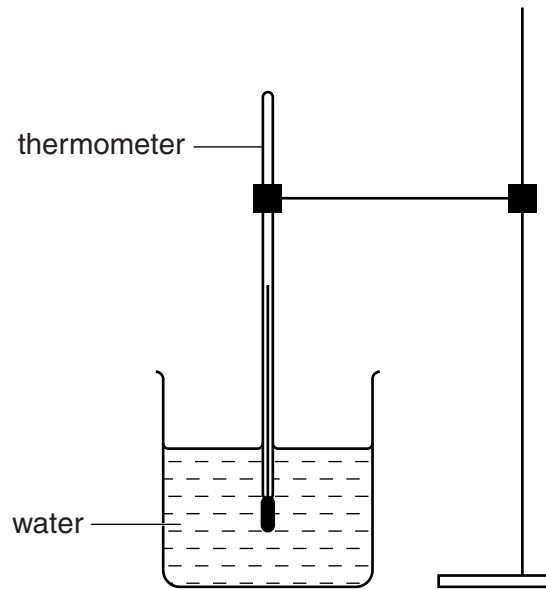

**Fig. 2.1**

- (a) Measure and record the temperature  $\theta_C$  of the cold water supplied.

$\theta_C = \dots\dots\dots$  [1]

- (b) (i) Pour approximately  $200\text{cm}^3$  of hot water into the beaker. Place the thermometer in the beaker of water. When the thermometer reading stops rising, measure the temperature  $\theta$  of the water in the beaker and immediately start the stopclock. In Table 2.1, record  $\theta$  at time  $t = 0\text{ s}$ .
- (ii) In the table, record the temperature of the water at 30 s intervals until you have a total of six values up to time  $t = 150\text{ s}$ .

**Table 2.1**

$t/\text{s}$	$\theta/^\circ\text{C}$
0	
30	
60	
90	
120	
150	

[2]

- (c) Empty the beaker. Pour approximately 200cm<sup>3</sup> of hot water into the beaker. Insert the thermometer in the beaker of water. When the thermometer reading stops rising, measure the temperature  $\theta_H$  of the water in the beaker.

$\theta_H = \dots\dots\dots$  [1]

- (d) (i) Pour 10cm<sup>3</sup> of the cold water into the beaker of hot water. Stir briefly. Measure and record the temperature  $\theta_1$  of the water.

$\theta_1 = \dots\dots\dots$  [1]

- (ii) Pour another 10cm<sup>3</sup> of the cold water into the beaker of hot water. Stir briefly. Measure and record the temperature  $\theta_2$  of the water.

$\theta_2 = \dots\dots\dots$  [1]

- (e) Using the evidence that you have from the table and the readings in parts (c) and (d), estimate the volume  $V$  of cold water that added to the hot water would give the same temperature drop as allowing the hot water to cool for 150s. Explain briefly how you arrived at your answer.

.....  
 .....  
 .....  
 .....

$V = \dots\dots\dots$  [2]

- (f) This laboratory investigation could be used as a small-scale model for a process in a factory. The laboratory investigation would be repeated many times.

Suggest two conditions that should be kept constant in order to provide reliable results.

- 1. ....
  - 2. ....
- [2]

[Total: 10]

3 In this experiment, you will determine the focal length of a lens.

Carry out the following instructions, referring to Fig. 3.1.



Fig. 3.1

- Place the lens a distance  $u = 25.0$  cm from the illuminated object. Move the screen until a sharply focused image of the object is seen on the screen.
- Measure, and record in Table 3.1, the height  $h$  of the image on the screen.
- Repeat the steps in (a) and (b) using  $u$  values of 30.0 cm, 35.0 cm, 40.0 cm and 45.0 cm.
- Calculate, and record in the table, the values of  $\frac{1}{h}$ .

Table 3.1

$u/\text{cm}$	$h/\text{cm}$	$\frac{1}{h}/\frac{1}{\text{cm}}$
25.0		
30.0		
35.0		
40.0		
45.0		

[2]



- (e) Plot a graph of  $u/\text{cm}$  ( $y$ -axis) against  $\frac{1}{h} / \frac{1}{\text{cm}}$  ( $x$ -axis). You do not need to begin the graph at the origin (0,0).

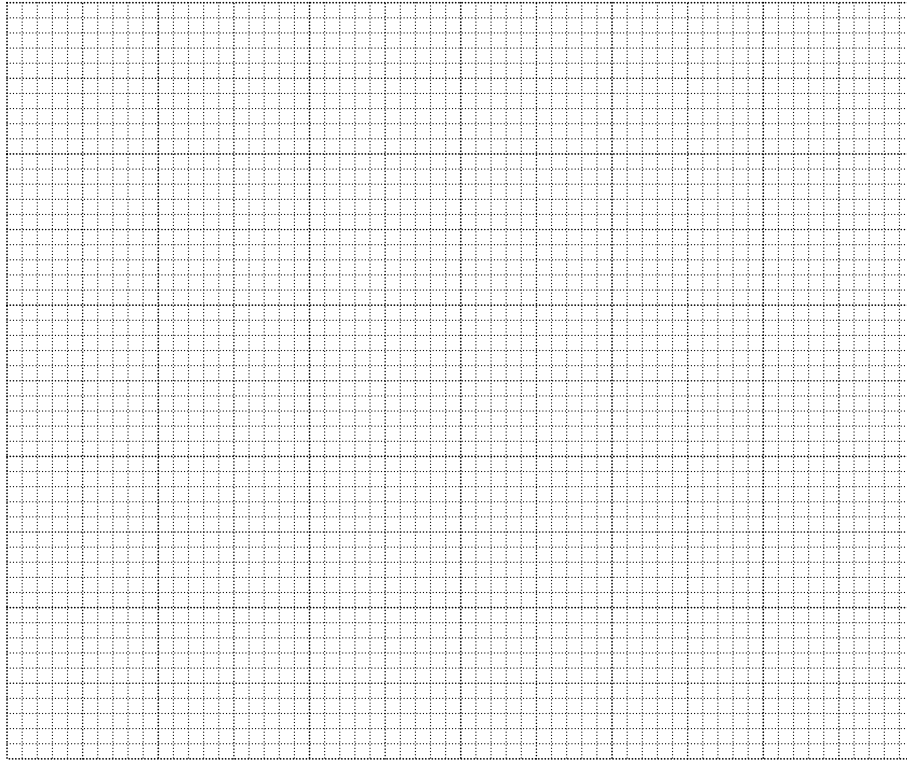

[4]

- (f) Determine the gradient  $G$  of the graph. Show clearly on the graph how you obtained the necessary information.

$G = \dots\dots\dots$ [2]

- (g) Calculate the focal length  $f$  of the lens, using the equation  $f = \frac{G}{1.5}$  cm. Give your answer to a suitable number of significant figures for this experiment.

$f = \dots\dots\dots$ [2]

[Total: 10]

- 4 In this experiment, you will investigate lamps in series and parallel combinations.

Carry out the following instructions, referring to Fig. 4.1.

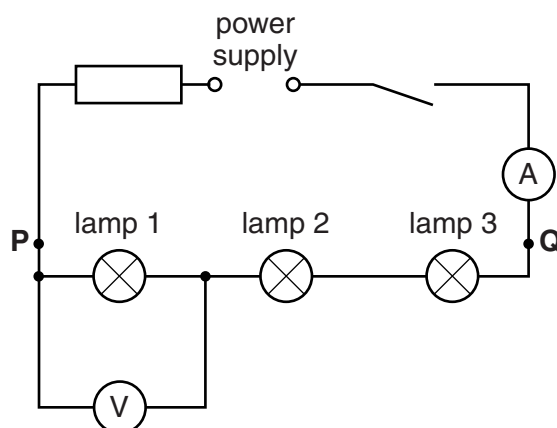

Fig. 4.1

- (a) (i) Switch on. Measure and record the potential difference  $V_1$  across lamp 1 and the current  $I$  in the circuit. Switch off.

$$V_1 = \dots\dots\dots$$

$$I = \dots\dots\dots$$

[2]

- (ii) Calculate the resistance  $R_1$  of lamp 1 using the equation  $R_1 = \frac{V_1}{I}$ .

$$R_1 = \dots\dots\dots [1]$$

- (iii) Disconnect the voltmeter and reconnect it to measure the potential difference  $V_2$  across lamp 2.

$$V_2 = \dots\dots\dots$$

- (iv) Disconnect the voltmeter and reconnect it to measure the potential difference  $V_3$  across lamp 3.

$$V_3 = \dots\dots\dots$$

[1]

- (v) Calculate the total potential difference  $V_T$  across the three lamps using the equation  $V_T = V_1 + V_2 + V_3$ .

$$V_T = \dots\dots\dots [1]$$

- (b) (i) Complete the circuit diagram in Fig. 4.2 to show the three lamps in parallel with each other between **P** and **Q**. Show the voltmeter connected to measure potential difference  $V_P$  across the lamps. Use standard symbols.

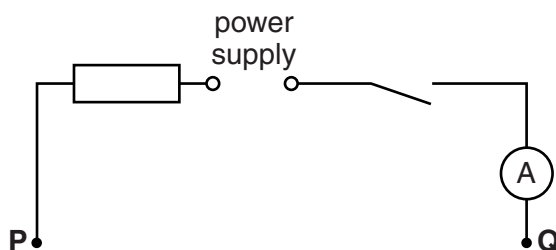

Fig. 4.2

[2]

- (ii) Disconnect the lamps and the voltmeter. Rearrange them to make the circuit shown in your circuit diagram.
- (iii) Switch on. Measure and record the potential difference  $V_P$  across the lamps and the total current  $I_T$ . Switch off.

$V_P = \dots\dots\dots$

$I_T = \dots\dots\dots$

- (iv) Calculate the total resistance  $R_P$  of the lamps arranged in parallel, using the equation  $R_P = \frac{V_P}{I_T}$ .

$R_P = \dots\dots\dots$

[1]

Question 4 continues on the next page.



- (c) A student suggests that  $R_p$  should be equal to  $\frac{R_1}{3}$ .

State whether your results support this suggestion and justify your answer by reference to the results.

statement .....

justification .....

..... [1]

- (d) Another student suggests that  $R_p$  may not be equal to  $\frac{R_1}{3}$  because the lamp filaments are hotter when the lamps are connected in parallel than when the lamps are connected in series.

State one piece of evidence that shows that the lamp filaments are hotter in the parallel circuit.

.....

..... [1]

[Total: 10]

Permission to reproduce items where third-party owned material protected by copyright is included has been sought and cleared where possible. Every reasonable effort has been made by the publisher (UCLES) to trace copyright holders, but if any items requiring clearance have unwittingly been included, the publisher will be pleased to make amends at the earliest possible opportunity.

University of Cambridge International Examinations is part of the Cambridge Assessment Group. Cambridge Assessment is the brand name of University of Cambridge Local Examinations Syndicate (UCLES), which is itself a department of the University of Cambridge.