



UNIVERSITY OF CAMBRIDGE INTERNATIONAL EXAMINATIONS  
International General Certificate of Secondary Education

CANDIDATE  
NAME

CENTRE  
NUMBER

--	--	--	--	--

CANDIDATE  
NUMBER

--	--	--	--

\* 3 7 3 1 7 6 1 3 2 1 \*

**COMBINED SCIENCE**

**0653/23**

Paper 2 (Core)

**May/June 2010**

**1 hour 15 minutes**

Candidates answer on the Question Paper.

No Additional Materials are required.

**READ THESE INSTRUCTIONS FIRST**

Write your Centre number, candidate number and name on all the work you hand in.

Write in dark blue or black pen.

You may use a soft pencil for any diagrams, graphs, tables or rough working.

Do not use staples, paper clips, highlighters, glue or correction fluid.

**DO NOT WRITE IN ANY BARCODES.**

Answer **all** questions.

A copy of the Periodic Table is printed on page 20.

At the end of the examination, fasten all your work securely together.

The number of marks is given in brackets [ ] at the end of each question or part question.

For Examiner's Use	
1	
2	
3	
4	
5	
6	
7	
8	
9	
<b>Total</b>	

This document consists of **19** printed pages and **1** blank page.



1 (a) Circle the characteristics in the list below that are shared by all living organisms.

- excretion    heartbeat    photosynthesis    sensitivity    sight

[2]

(b) A student peeled a layer of cells from the inside of an onion bulb. She placed them in a drop of water on a microscope slide and covered them with a coverslip.

Fig. 3.1 shows what she saw when viewing the cells through a microscope.

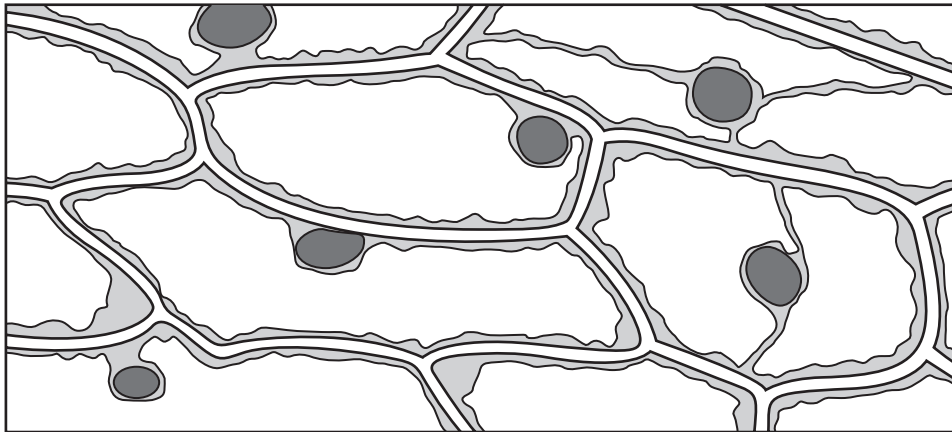

Fig. 3.1

(i) The cells in Fig. 3.1 are all similar to each other.

Give the name for a group of similar cells. .... [1]

(ii) State **two** ways in which the cells in Fig. 3.1 differ from animal cells.

1 .....

2 ..... [2]

(c) Onion cells often contain stores of starch. When a person eats an onion, the starch is digested.

(i) Explain why nutrients such as starch must be digested before they can be used by the human body.

.....

.....

..... [2]

(ii) Outline the roles of each of the following in the digestion of starch.

teeth .....

.....

enzymes .....

..... [2]

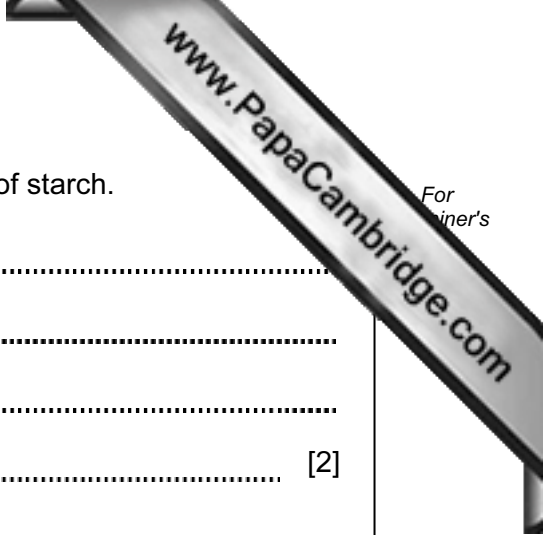

- 2 The Periodic Table on page 20 shows the chemical elements in rows (left to right) and columns (up and down).

(a) (i) A column of elements in the Periodic Table is called a group.

What is a row of elements called? ..... [1]

(ii) State the chemical symbol of the element which has a proton (atomic) number of 32.

..... [1]

(b) Table 2.1 shows the uses of some elements.

Complete the table by writing the names of elements chosen from the list into the correct boxes.

**aluminium**                      **carbon**                      **chlorine**                      **helium**  
**iron**                              **nitrogen**                      **sodium**                      **xenon**

**Table 2.1**

<b>element</b>	<b>use</b>
	used to make food containers because it does not react with food
	used to sterilise drinking water because it kills harmful bacteria
	used in airships because it is an unreactive gas which is much less dense than air

[3]

- (c) A teacher placed a small piece of potassium into a container filled with chlorine. She also mixed together some iron filings and sulfur powder.

Fig. 2.1 shows what the class observed.

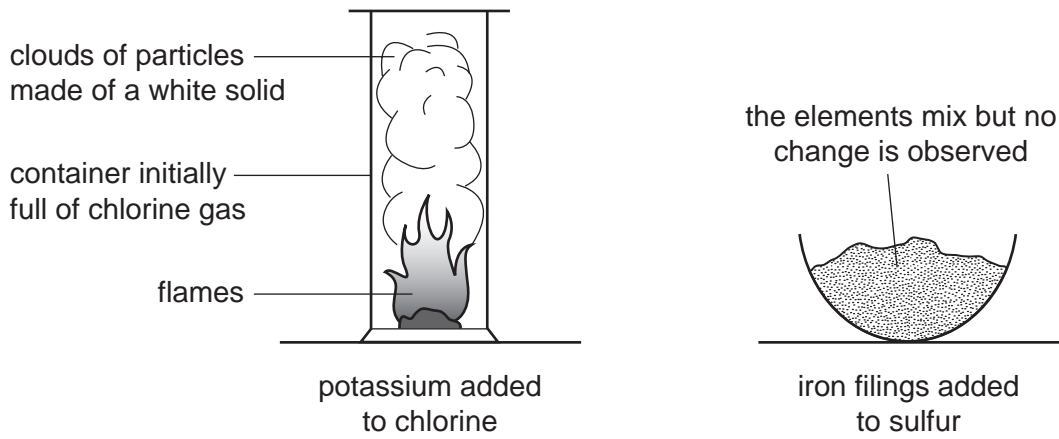

Fig. 2.1

- (i) State **two** observations which showed that the elements potassium and chlorine were combining to form a compound.

1 .....

.....

2 .....

..... [2]

- (ii) Suggest the **word** chemical equation for the reaction between potassium and chlorine.

..... [1]

- (iii) Iron sulfide is a compound made of the elements iron and sulfur.

Using this example, describe **two** ways in which a mixture of two elements differs from a compound of the elements.

1 .....

.....

2 .....

..... [2]

- 3 (a) Fig. 3.1 shows an astronaut on a space walk. His space suit is designed to protect him from dangerous electromagnetic radiation from the Sun reaching the astronaut's body.

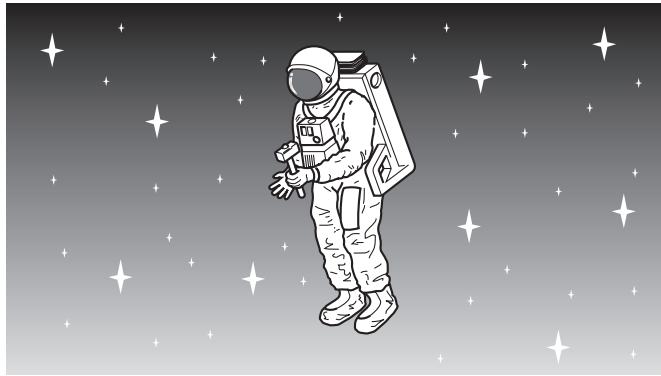

Fig. 3.1

- (i) Name **two** types of electromagnetic radiation that can harm the body.

1 .....

2 .....

[2]

- (ii) State **one** way in which electromagnetic radiation can harm the body.

..... [1]

- (b) Two astronauts are in a rocket being launched to the Moon. One of the astronauts has a mass of 96 kg. The gravitational field strength on the Moon is about one sixth of that on Earth.

State the difference, if any, between

- (i) the mass of the astronaut on the Earth and on the Moon,

..... [1]

- (ii) the weight of the astronaut on the Earth and on the Moon.

..... [1]

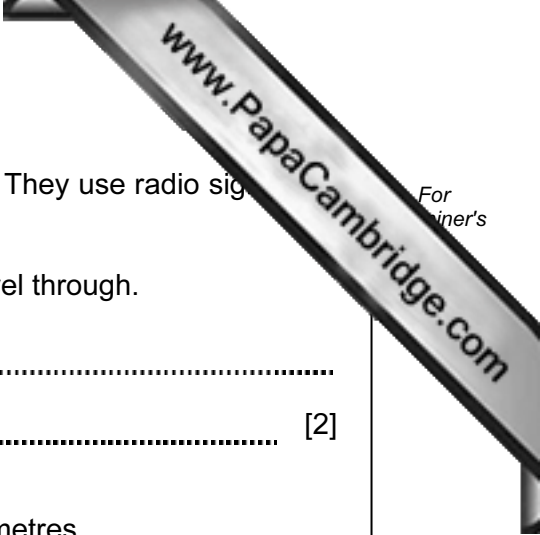

- (c) The astronauts land on the Moon, which has no atmosphere. They use radio signals to talk to each other.

Explain why sound waves need a medium, such as air, to travel through.

.....  
..... [2]

- (d) A rock on the moon weighs 6 N. The astronaut lifts it up by 2 metres.

Calculate the work done on the rock.

State the formula that you use and show your working.

formula

working

..... J [2]

4 (a) A student investigated the conditions needed for the germination of mustard seeds.

Fig. 4.1 shows the apparatus at the start of his experiment.

Tubes **A** to **E** were placed in the laboratory at room temperature. Tube **E** was placed in a freezer at  $-4^{\circ}\text{C}$ .

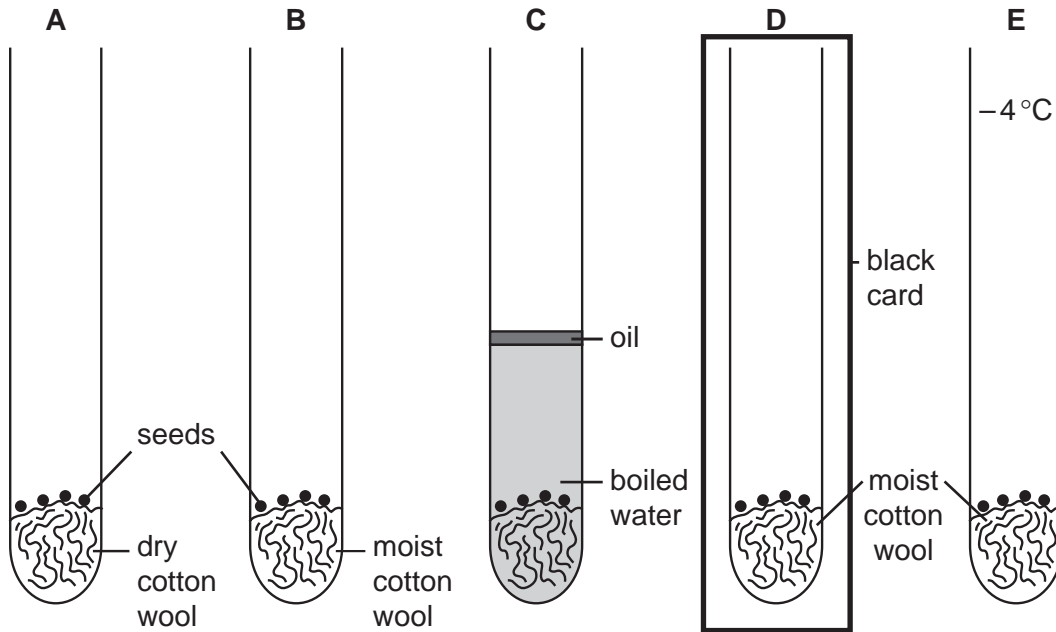

Fig. 4.1

(i) Which **one** of these factors should the student have kept the same for all of the tubes? Circle the correct answer.

**age of seeds**                      **amount of water**                      **temperature**                      [1]

(ii) After three days, the seeds in tubes **B** and **D** had germinated.

The seeds in all the other tubes had not germinated.

Use these results to deduce the conditions needed for the germination of mustard seeds.

.....

.....

.....

..... [3]



- (b) In a tropical rainforest, the trees often grow very closely together, which reduces the amount of light reaching the forest floor.

The seeds of many species of rainforest trees will not germinate unless they get plenty of light.

- (i) Suggest why this is an advantage to the seedlings.

.....  
 ..... [1]

- (ii) In a separate experiment the student used seeds of rainforest trees.

State the tube in Fig. 4.1 in which the result would differ from those he obtained for mustard seeds.

..... [1]

- (c) (i) Tropical rainforests have a very large number of different plant species.

Suggest how this could lead to a high species diversity of animals in tropical rainforests.

.....  
 .....  
 .....  
 ..... [2]

- (ii) When rainforests are cut down, species diversity is reduced.

Explain how else cutting down rainforests may damage the environment.

.....  
 .....  
 .....  
 ..... [3]

5 Some fuels are listed below.

- animal dung
- coal
- methane
- wood

(a) (i) State **one** fuel from the list which is an example of a fossil fuel.

Explain your answer.

example of a fossil fuel .....

explanation .....

.....

..... [2]

(ii) The chemical formulae of some substances which can be used as fuels are shown below.

- $C_2H_6O$
- $H_2$
- $CO$
- $C_2H_2$
- $C$

Explain which **one** of these formulae represents one molecule of a *hydrocarbon*.

.....

.....

..... [2]

(b) At an oil refinery, useful products are separated from petroleum (crude oil).

Complete the sentences by choosing terms from the list below.

- boiling points
- colours
- catalytic cracking
- filtration
- filtered
- fractional distillation
- heated
- stirred

The process used to separate petroleum into useful products is called

.....

In this process, petroleum is .....

Different products separate because they have different

.....

[3]

- (c) A student suggested that when the liquid fuel ethanol is burned, carbon dioxide should be produced.

Fig. 5.1 shows apparatus which he used to find out if this was true.

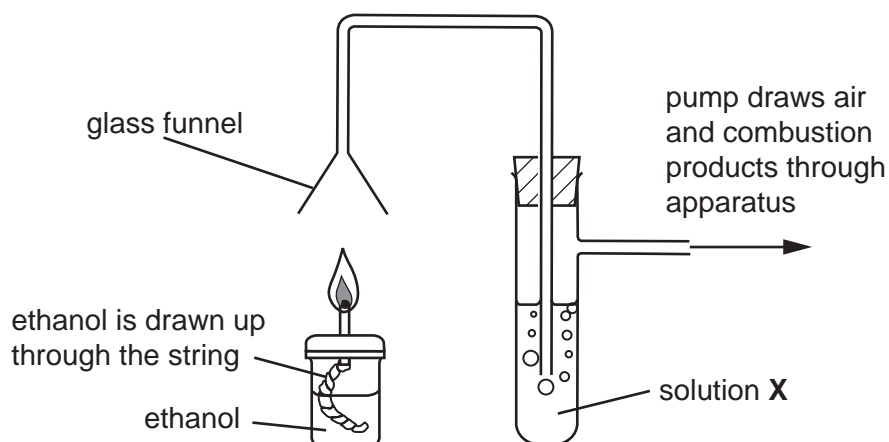

Fig. 5.1

- (i) Solution **X** is used to test for carbon dioxide.

Name solution **X**, and describe what would be observed if the combustion of ethanol does produce carbon dioxide.

solution **X** .....

observation .....

..... [2]

- (ii) Explain why the combustion of ethanol is an example of an oxidation reaction.

.....

..... [1]

6 Fig. 6.1 shows a cube.

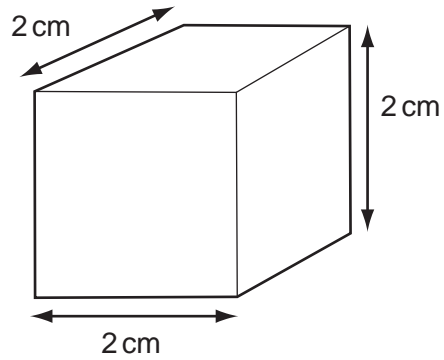

Fig. 6.1

(a) (i) Name a suitable piece of apparatus for measuring the length of the cube.

..... [1]

(ii) Calculate the volume of the cube.

.....  $\text{cm}^3$  [1]

(iii) The mass of the cube is 21.6 g.

Calculate the density of the cube.

State the formula that you use and show your working.

formula

working

.....  $\text{g/cm}^3$  [2]

(b) The solid cube is made up of very small particles.

Fig. 6.2 shows their arrangement.

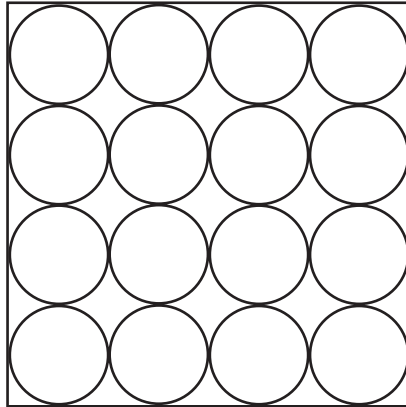
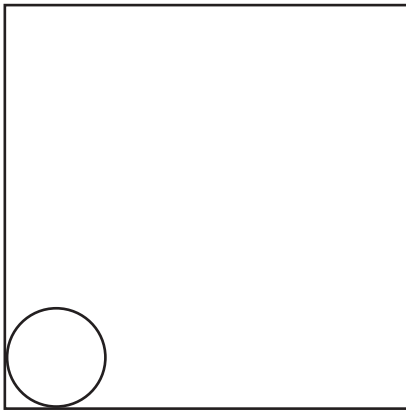
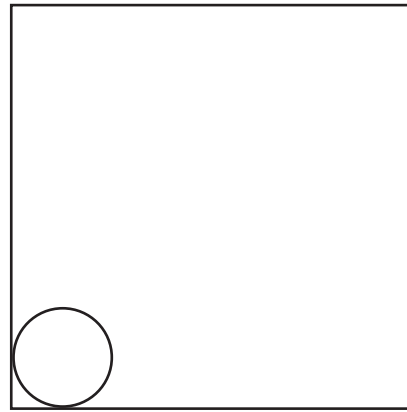

Fig. 6.2

Complete the diagrams below to show the arrangement of particles in a liquid and in a gas.



liquid



gas

[2]

(c) (i) Explain, in terms of particles, why a solid expands when heated.

.....  
..... [1]

(ii) Describe **one** problem caused by a solid metal expanding when it gets hot.

.....  
.....  
..... [2]

- 7 When magnesium metal reacts with dilute hydrochloric acid, a soluble salt and a gas are produced.

(a) Complete the **word** chemical equation for the reaction between magnesium and hydrochloric acid.

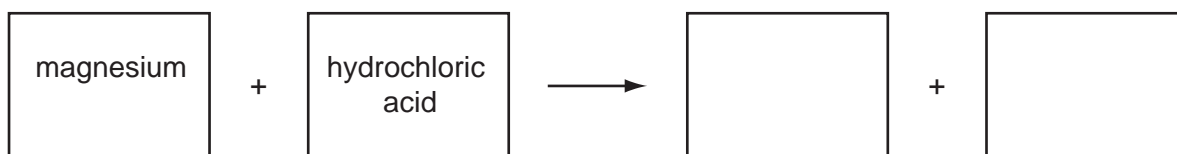

[2]

(b) A student used the apparatus in Fig. 7.1 to investigate the rate of this reaction.

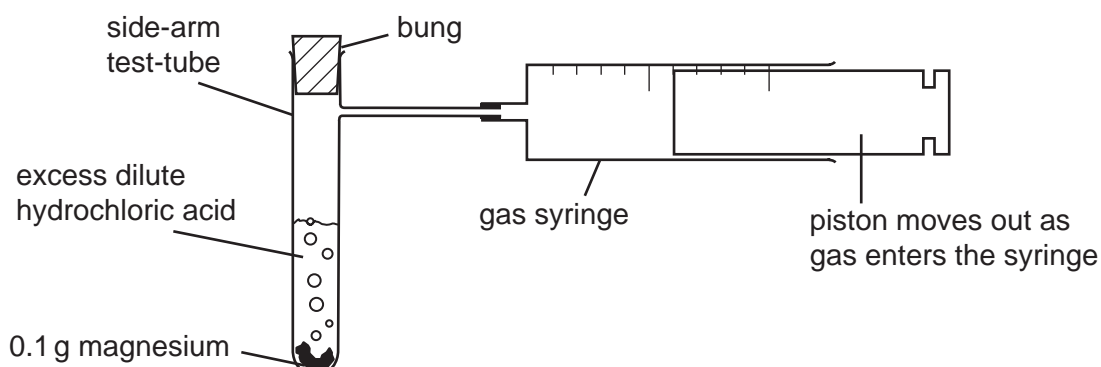

Fig. 7.1

The student dropped the magnesium into the acid contained in the side-arm test-tube and put in the bung.

A stopwatch was used to time how long it took for the gas syringe to fill with gas.

The student carried out two experiments and the results are shown in Table 7.1.

Table 7.1

experiment	time taken to collect 100 cm <sup>3</sup> of gas / seconds
1	45
2	31

- (i) Explain how the results show that the rate of reaction in experiment 2 was higher than that in experiment 1.

.....  
 ..... [1]

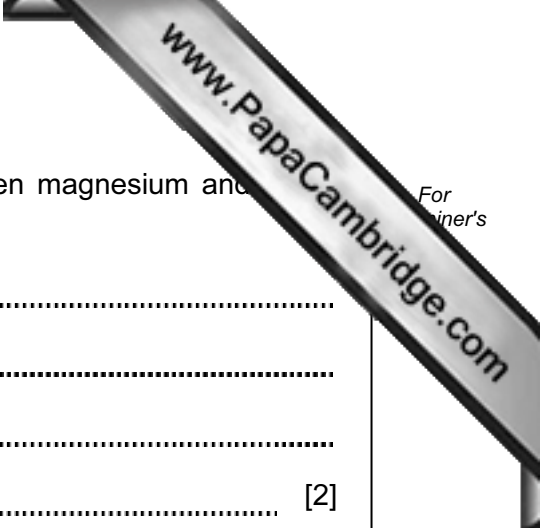

(ii) Suggest **two** ways in which the rate of reaction between magnesium and hydrochloric acid could be increased.

1 .....

.....

2 .....

..... [2]

(iii) Sodium is an alkali metal in Group 1 of the Periodic Table.

Explain why the student must not attempt the experiment shown in Fig. 7.1 using sodium instead of magnesium.

.....

.....

..... [2]

- 8 (a) A torch (flash light) contains two cells providing a total voltage of 3.0 V across the lamp. When the torch is lit, the current flowing through the lamp is 0.3 A.

- (i) Calculate the resistance of the lamp.

State the formula that you use, show your working, and state the units of resistance.

formula

working

..... [3]

- (ii) To measure the current through the lamp and the voltage across the lamp, the student set up the circuit in Fig. 8.1.

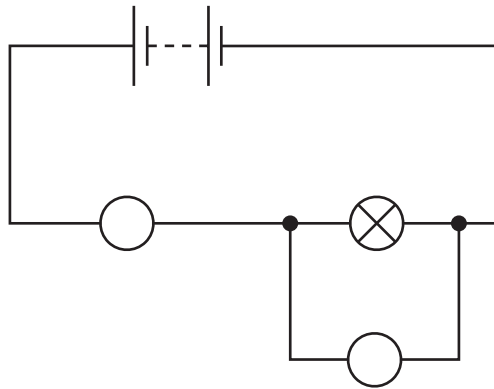

Fig. 8.1

Write the letters **A** and **V** in the two circles on the diagram to show the correct positions of the ammeter (**A**) and voltmeter (**V**). [1]



- (b) Complete the sentences below to describe the energy changes which take place when the torch is used.

Choose from the words given.

**chemical**

**electrical**

**heat**

**kinetic**

**light**

**nuclear**

**potential**

**sound**

Energy is stored in the cells as ..... energy. This is changed into ..... energy which passes through the lamp. The useful energy output from the lamp is ..... energy, but much energy is wasted as ..... energy. [4]

9 Fig. 9.1 shows a section through a human heart seen from the front.

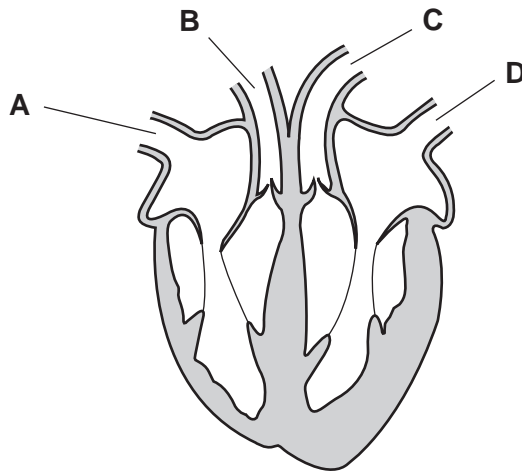

Fig. 9.1

(a) (i) The walls of the heart are made of cardiac muscle.

Describe the function of the cardiac muscle in the heart.

.....  
 .....  
 ..... [2]

(ii) State the name of the blood vessels that supply the cardiac muscle with oxygen.

..... [1]

(iii) Give the letters of the **two** labelled blood vessels in Fig. 9.1 that contain oxygenated blood.

..... and ..... [1]

(b) Plants also have transport systems in which liquids flow through vessels. However, they do not have a heart.

Instead, transpiration pulls water up through the plant.

(i) Explain what is meant by the term *transpiration*.

.....  
 .....  
 ..... [2]

(ii) Name the vessels through which water travels up a plant.

..... [1]

BLANK PAGE

