

Centre Number	Candidate Number	Name
---------------	------------------	------

UNIVERSITY OF CAMBRIDGE INTERNATIONAL EXAMINATIONS  
International General Certificate of Secondary Education

**COMBINED SCIENCE**

**0653/06**

**CO-ORDINATED SCIENCES**

**0654/06**

Paper 6 Alternative to Practical

October/November 2005

**1 hour**

Candidates answer on the Question Paper.  
No Additional Materials required.

**READ THESE INSTRUCTIONS FIRST**

Write your Centre number, candidate number and name on all the work you hand in.  
Write in dark blue or black pen in the spaces provided on the Question Paper.  
You may use a soft pencil for any diagrams, graphs or rough working.  
Do not use staples, paper clips, highlighters, glue or correction fluid.

Answer **all** questions.  
The number of marks is given in brackets [ ] at the end of each question or part question.

If you have been given a label, look at the details. If any details are incorrect or missing, please fill in your correct details in the space given at the top of this page.

Stick your personal label here, if provided.

For Examiner's Use	
1	
2	
3	
4	
5	
6	
<b>Total</b>	



1 A student carried out some tests on seeds at two different stages of germination. She started with sample **A**, some seeds that had been soaking for a few hours. She crushed the seeds and tested a small portion with iodine solution. She tested the remainder for the presence of reducing sugar.

(a) (i) Describe how you would test the crushed seeds for the presence of reducing sugar.

.....  
 ..... [2]

(ii) Complete Fig. 1.1.

test	colour observed after test	conclusion
iodine solution added	blue/black	
test for reducing sugar		no reducing sugar present

[2]

Fig. 1.1

(b) (i) The student repeated the reducing sugar test on seeds in sample **B** that had been germinating for a few days. The seeds had formed roots and shoots which were removed before the test. Complete Fig. 1.2.

test	colour observed after test	conclusion
test for reducing sugar		reducing sugar present

[1]

Fig. 1.2

(ii) Compare the results of the two reducing sugar tests and explain the difference between them.

.....  
 .....  
 .....  
 .....  
 ..... [3]

- 2 The teacher set up a circuit containing a 3.0V d.c. supply, three identical lamps and an ammeter, as shown in Fig. 2.1.

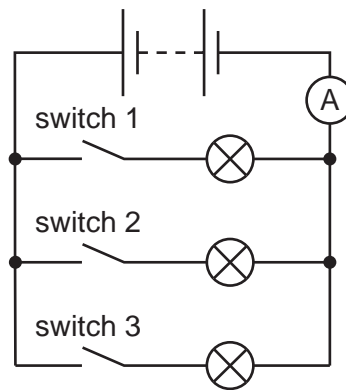

Fig. 2.1

No current flowed, and there was no ammeter reading, until one or more of the switches were closed.

Fig. 2.2 shows the ammeter readings for three different combinations of switches.

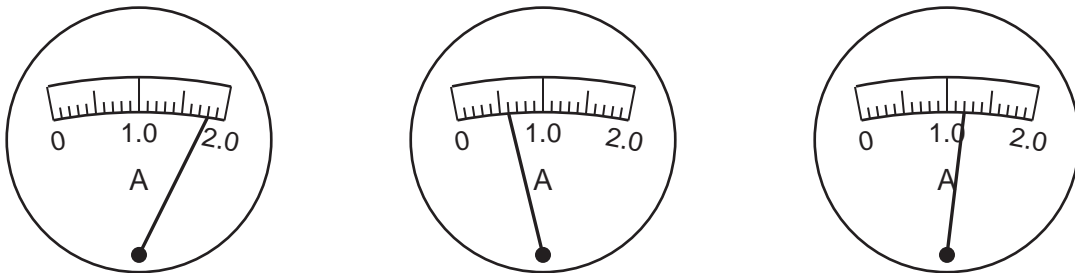

Fig. 2.2

ammeter reading /A			
switch(es) that were closed	1, 2 and 3		

Fig. 2.3

- (a) (i) Read the ammeters in Fig. 2.2 and record the readings in the first line of Fig. 2.3. Take care to match the correct reading with the switch combination already noted in Fig. 2.3. [3]
- (ii) Decide which switches were closed to give the other readings that you have recorded in the table, and then complete Fig. 2.3. [2]

- (iii) The power supply had an e.m.f. of 3.0 V. Use information from Fig. 2.3 to calculate the resistance of **one** of the three lamps.

..... ohms [1]

- (b) The lamps are connected **in parallel** in Fig. 2.1.  
In the space below, draw a circuit that the student can use, containing three lamps **in series** with the 3.0 V power supply and the ammeter. [2]

- (c) When the student set up the circuit with the lamps in series, he was surprised to find that the current was less than any of the readings shown in Fig. 2.2.

- (i) Explain why the current was less when the lamps were connected in series.

..... [1]

- (ii) Compare the brightness of a lamp in the series circuit and a lamp in the parallel circuit.

..... [1]

- 3 Brass is an alloy of the metals zinc and copper. A student is given a sample of brass filings. The student wants to find out what percentage of copper is contained in brass. He knows that zinc dissolves in hydrochloric acid, but copper does not dissolve in it.

- (a) The student weighs the sample of brass. Read the balance windows in Fig. 3.1 and record the readings in the spaces provided. Calculate the mass of brass used.

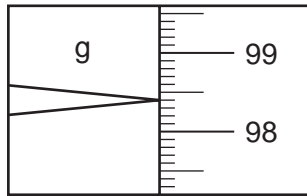

mass of beaker

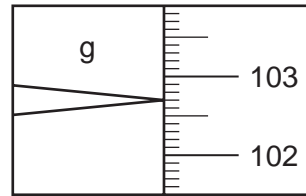

mass of beaker and brass

Fig. 3.1

- (i) mass of beaker + brass = ..... g [1]
- (ii) mass of beaker = ..... g [1]
- (iii) mass of brass = ..... g [1]

- (b) The student adds 50 cm<sup>3</sup> (an excess) of hydrochloric acid.

- (i) What will the student observe when the acid is added?

..... [1]

- (ii) How will he know when all the zinc has dissolved?

..... [1]

- (iii) Describe the appearance of the copper residue.

..... [1]

- (c) After the reaction has finished, the student pours away the liquid. He washes the copper residue with water. Then he dries the residue in an oven. Finally he reweighs the beaker containing the copper.

Fig. 3.2 shows the balance window.

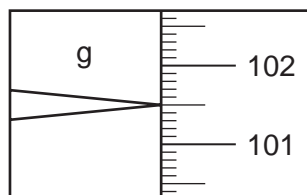

mass of beaker and copper

**Fig. 3.2**

Read and record the mass of the beaker + copper, then calculate the mass of the copper.

(i) mass of beaker + copper = ..... g [1]

(ii) mass of copper = ..... g [1]

- (d) Use the results of (a) and (c) to calculate the percentage of copper in the original sample of brass.

[2]

- 4 A student did an experiment to find out what happened to his pulse rate when he exercised.
- He rested for a few minutes, then he took his pulse for one minute. It was 76 beats per minute.
  - The student then exercised vigorously for five minutes. When he finished he immediately took his pulse for 15 seconds. He counted 40 pulse beats and recorded it. This was his reading at time 0 minutes.
  - He repeated his pulse reading one minute after he finished exercising.
  - He then did four further readings at one minute intervals until his pulse returned to normal.

The results are shown in Fig. 4.1.

time after exercising/min	number of pulse beats/15 s	pulse rate/beats per minute
0	40	160
1	33	
2	27	108
3		88
4	20	
5	19	76

**Fig. 4.1**

- (a) (i) Complete Fig. 4.1 by adding the missing values. [3]
- (ii) Draw a graph of pulse rate/beats per minute against time after exercise.

pulse rate after  
exercising/  
beats per min

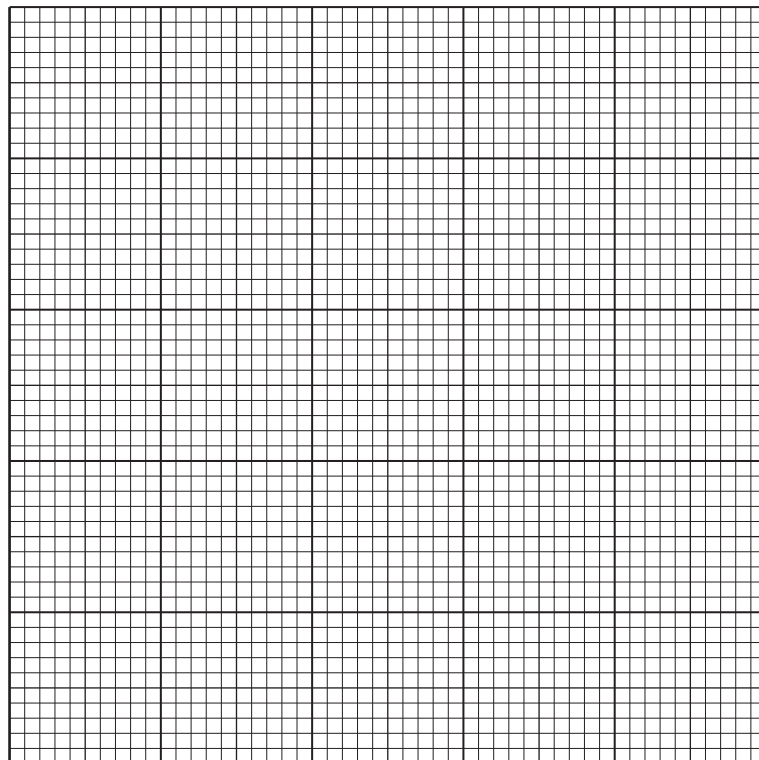

time after exercise / min

[3]



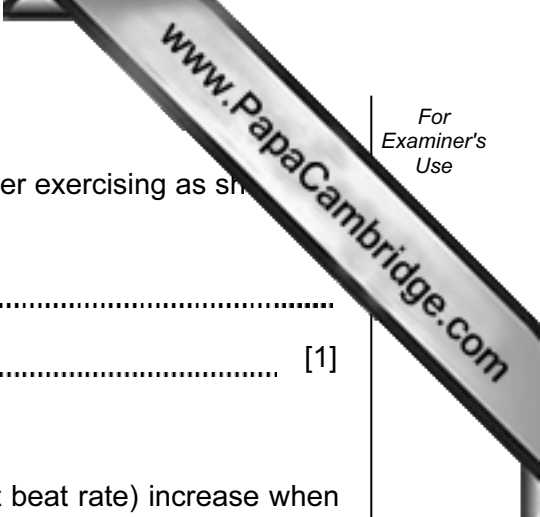

(iii) Describe the relationship between pulse rate and time after exercising as shown in your graph.

.....  
..... [1]

(b) (i) Why did the student's pulse rate (and therefore his heart beat rate) increase when he exercised?

.....  
..... [2]

(ii) Explain why the pulse rate took time to return to normal.

.....  
..... [1]

(c) Suggest how the experiment could be modified to find if the drug caffeine, found in coffee, affects the heart beat rate.

.....  
.....  
.....  
..... [2]

- 5 A student carried out tests on two solids, **A** and **B**. Both of these solids decompose when heated.  
Complete Fig. 5.1 to show the missing results and conclusions.

test	result	conclusion
<b>(a)(i)</b> Solid <b>A</b> was heated in a dry test-tube.	The white powder turned yellow and a gas was given off	
<b>(a)(ii)</b> The gas given off in <b>(a)(i)</b> was tested with moist red litmus paper	the litmus paper stayed red	[1]
<b>(a)(iii)</b> The gas given off in <b>(a)(i)</b> was tested using limewater.	[1]	the gas was carbon dioxide
<b>(b)(i)</b> Solid <b>B</b> was gently heated in a dry test-tube.	The light green crystals turned to a white solid. A vapour was given off. The vapour condensed on a cold surface.	[1]
<b>(b)(ii)</b> The residue from <b>(b)(i)</b> was heated more strongly	the white solid turned brown and smoky fumes were given off.	
<b>(b)(iii)</b> The fumes from <b>(b)(ii)</b> were tested using a glowing splint	the splint did not re-light	[1]
<b>(b)(iv)</b> The fumes from <b>(b)(ii)</b> were tested using moist blue litmus paper	[1]	the fumes were acid

Fig. 5.1

- (c) In the space below, draw a labelled diagram of the test-tube in which solid **B** is heated. Show in the diagram how the gas given off is tested using moist red litmus paper.

- (d) Carefully explain how you would carry out the glowing splint test on the fumes given off by solid **B**. Do not draw a diagram.

.....  
.....  
..... [1]

- (e) Solid **B** is known to be a compound of iron. Describe a test you could use to decide whether **B** is an iron(II) or an iron(III) compound. Give the results you would expect for both iron(II) and iron(III) compounds.

.....  
.....  
.....  
.....  
..... [3]

- 6 A student did an experiment to find out if changing the mass of a pendulum has any effect on the time of swing.

The pendulum he used was a lump of plasticine on a piece of string.

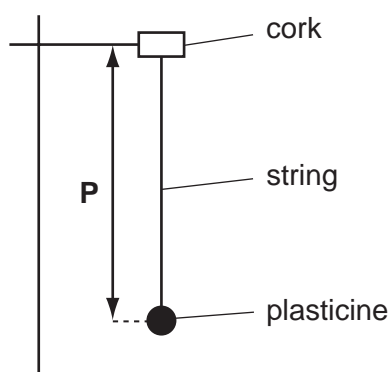

Fig. 6.1

- He weighed the pendulum to the nearest gram and recorded its mass in Fig. 6.2.
- He attached the string to the clamp. He pulled the pendulum to one side and allowed the pendulum to swing. He used a stopclock to find the time taken for 20 swings, to the nearest second, and noted it in Fig. 6.2
- He removed about 10 g of plasticine and weighed the pendulum again. He found the time taken for 20 swings, as before.
- He repeated the previous step until he had five sets of readings.

mass of pendulum/g	time for 20 swings/s	time for 1 swing /s
87	37	1.85
55	38	1.90
43	37	1.85

Fig. 6.2

- (a) (i) Fig. 6.3 shows the balance windows and stopclock dials for the two readings missing from Fig. 6.2.  
Read the masses and times and record them in Fig. 6.2.

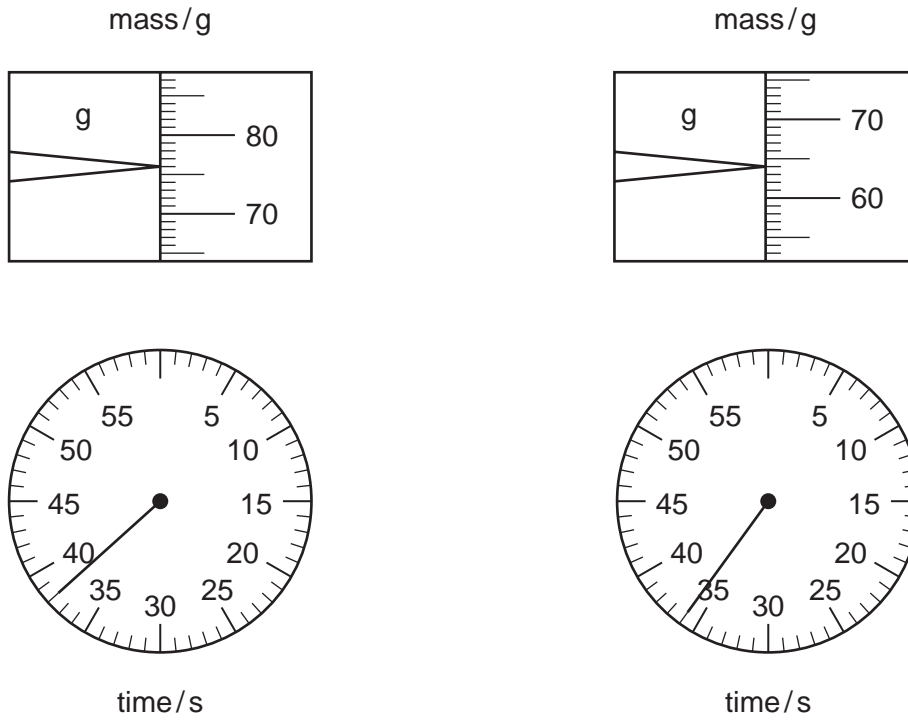
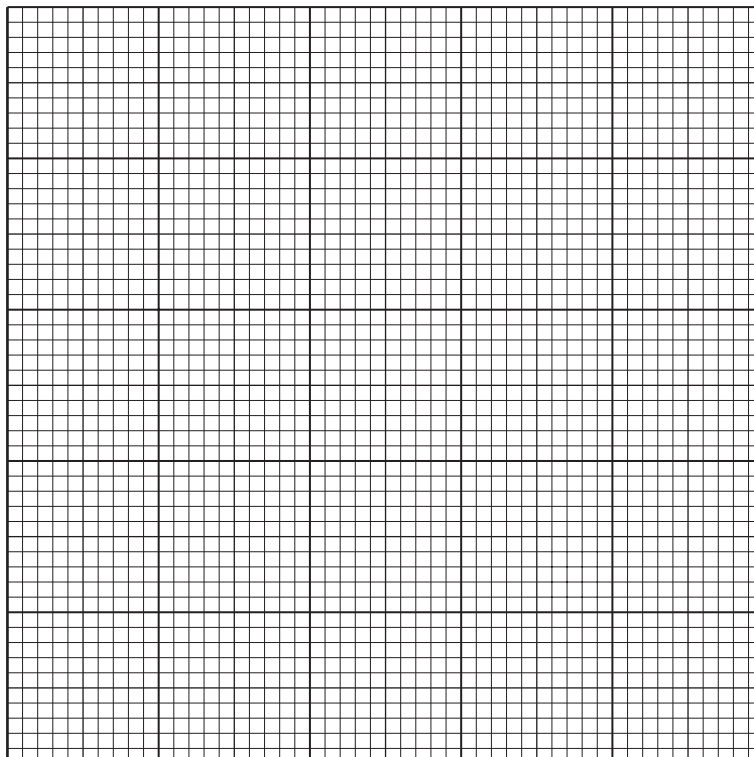

Fig. 6.3

- (ii) Complete Fig. 6.2 by calculating the time for 1 swing for the readings noted in (a)(i). [1]
- (b) On the grid provided, plot a graph of time for 1 swing (vertical axis) against mass of pendulum.



(c) What does the graph show about the effect of changing the mass of the pendulum on the time of swing?

..... [1]

(d) Suggest a factor that might have an effect on the time taken for 1 swing of the pendulum.

..... [1]

